

ALL STRAP AVAILABLE IN:  
 CARBON STEEL (BARE, SHOP PRIMED OR HOT DIP GALVANIZED)  
 STAINLESS STEEL - T304L OR T316L (BARE)

PIPE SIZE	MATERIAL	BOLT SIZE
Ø4"	¼" THK. x 2" WIDE	Ø <sup>5</sup> / <sub>8</sub> "
Ø6"	¼" THK. x 2" WIDE	Ø <sup>5</sup> / <sub>8</sub> "
Ø8"	¼" THK. x 2" WIDE	Ø <sup>5</sup> / <sub>8</sub> "
Ø10"	¼" THK. x 2" WIDE	Ø <sup>5</sup> / <sub>8</sub> "
Ø12"	¼" THK. x 2" WIDE	Ø <sup>5</sup> / <sub>8</sub> "
Ø14"	¾" THK. x 2" WIDE	Ø <sup>3</sup> / <sub>4</sub> "
Ø16"	¾" THK. x 2" WIDE	Ø <sup>3</sup> / <sub>4</sub> "
Ø18"	¾" THK. x 3" WIDE	Ø <sup>3</sup> / <sub>4</sub> "
Ø20"	¾" THK. x 3" WIDE	Ø <sup>3</sup> / <sub>4</sub> "

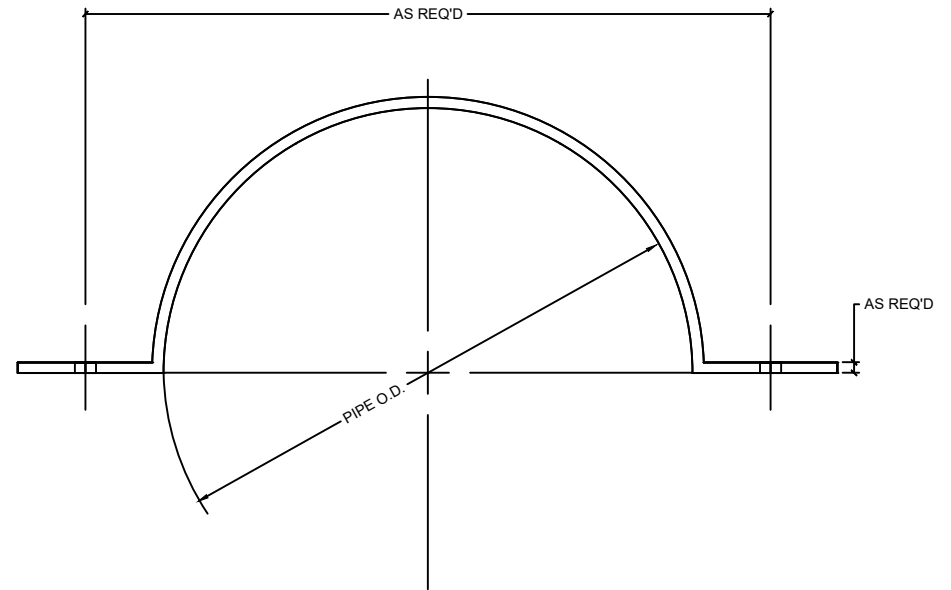
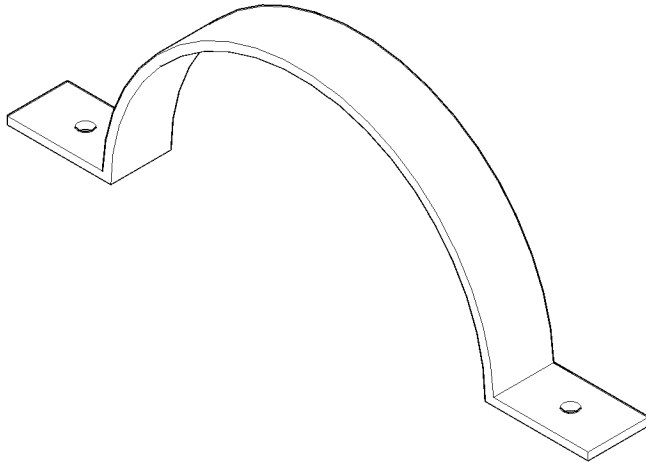

"Quality Steel Fab for the Waterworks Industry"  
[www.pipesupportsplus.com](http://www.pipesupportsplus.com)

THIS DRAWING IS THE PROPERTY OF PIPE SUPPORTS PLUS AND MUST BE RETURNED UPON REQUEST. REPRODUCTION HEREOF OR TRANSMISSIONS MAY NOT BE MADE WITHOUT CONSENT

APPROVED FOR FABRICATION

SIGN : \_\_\_\_\_

PRINT : \_\_\_\_\_

DATE : \_\_\_\_\_

Description

180° PIPE STRAP

File

180° Pipe Strap.dwg

Drawn

MAP

Date

5/11/2021

N.T.S

ALL DIMENSIONS ARE IN INCH.